

ELECTRICAL VALVES

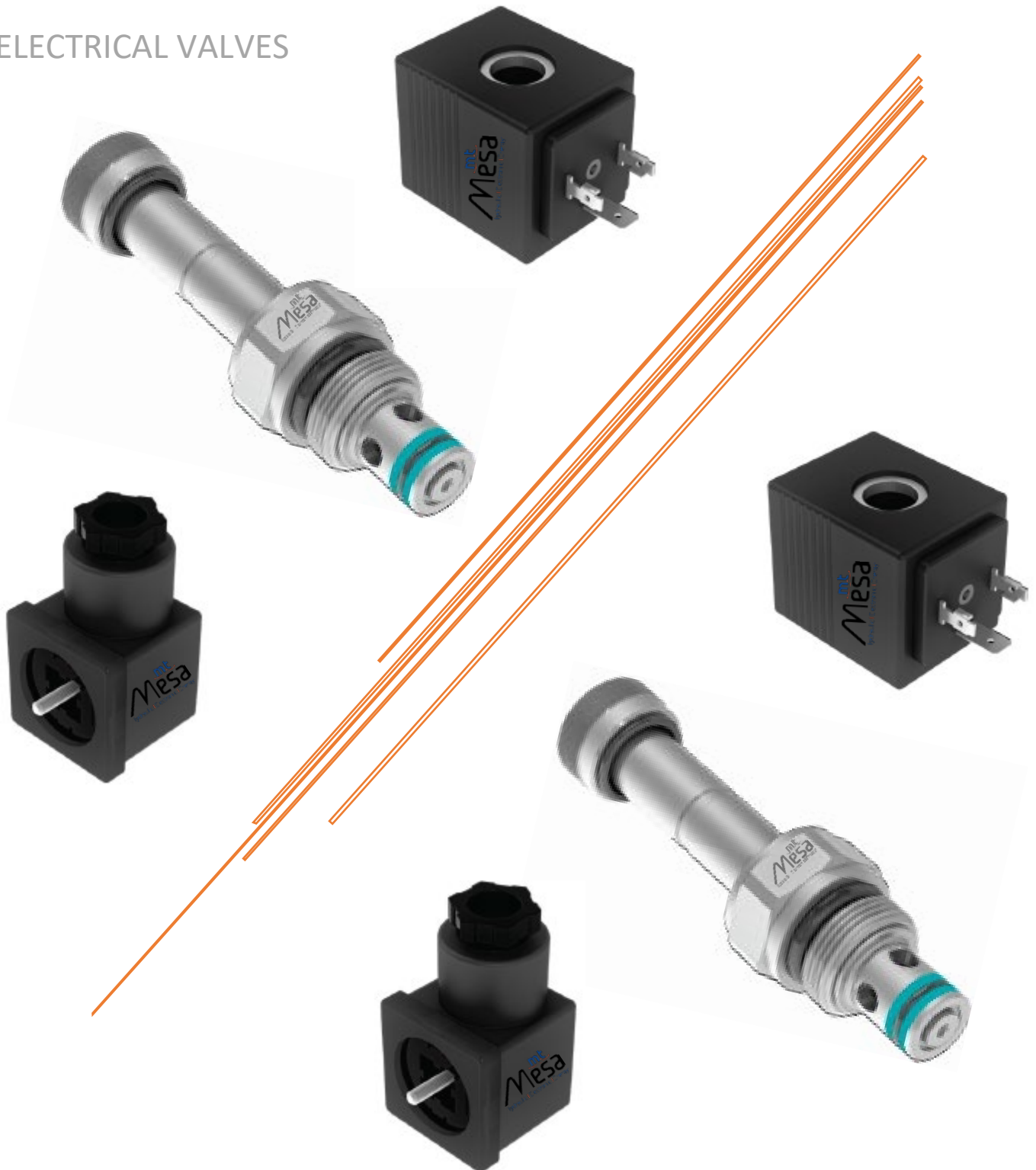

# about US

As a innovative enhancer of Fluid Power Transmission Industry that MT MESA is became a global leader with its premium quality products in Global Hydraulics markets.

From the beginning till today, We provide R&D to contribute the sustainable and smart product solutions for components, systems of drive and automation technology in MT MESA.

MT MESA is one of the major suppliers among the Fluid Power Engineering Industry Professional manufacturers to the entire mechanical-engineering industry and many other industries, such as electrical engineering, construction and agricultural machinery, conveyor systems, chemical industry, food and packaging machinery, woodworking, machine tools, shipbuilding, the metal industry, mining and environmental technology.

## ADVANCED MANUFACTURING;

Today, companies divide their operations across the world, from the design of the product and manufacturing of components to assembly and marketing, creating international production chains.

Both MESA MAKINA A.S. and MT MESA has operating from the engineering design, casting and machining till to assembling lines and shipment operations in same integrated facility. This business awareness and production ability enables us the strongest position in our business scope by means of our R&D Center guided business operations inhouse. Our global – nationwide shipment operations are carried out under the same roof. By this way our patented products are delivered in time.

MT MESA has also ISO 9001 and IATF 16949, ISO 14001, ISO 18001, ISO 27001 Certificates since 2000. The EFQM Excellence Model is the only company that has a 4 Star Quality Competency Certificate and has received an award.

## A GAME CHANGER;

MT MESA - MESA MAKINA A.S. is the indivisible part of International Fluid Power Society as a member of Akışkan Gücü Derneği (AKDER) – Accredited to CETOP (Comité Européen des Transmissions Oléohydrauliques et Pneumatiques ,European Fluid Power Committee).

As a part of MESA MAKINA A.S. , MT MESA has international business interactions and professional collaborations with leading USA & EU business partners in Hydraulic Industry.

MT MESA offers you a wide range of filtration solutions to meet with your hydraulic system requirements perfectly. We ultimately care about all customer feedback to provide smart & quick solutions for the hydraulic sector professionals, students and individuals.



# technical INFORMATION

Please read these instructions carefully before installation. All operations must be carried out by specialized and competent personnel.

The user must periodically check the condition and correct functioning of the valves, the corrosion and the condition of the hydraulic installation.

**Always respect the technical prescriptions of the valve.**

## OIL

Use only mineral oil (HL, HLP) according to DIN 51524. The use of other fluids may cause bad working of the valve.

## OPERATING TEMPERATURES

Environment temperature: -25°C to +60°C

Oil temperature (with NBR seals): from -25°C to +75°C

## VISCOSITY

The viscosity of the oil should be in the range of 15 mm<sup>2</sup>/s to 250mm<sup>2</sup>/s.

Recommended viscosity ISO VG 46 (for cartridge valves ISO VG 32).

## CONTAMINATION AND FILTRATION

Excessive fluid contamination is the main cause of bad-working in hydraulic installations.

Max. contamination with filter ISO 4406:1999 - class 19/17/14

The use of filters is necessary to protect the system from bad-working, in order to avoid serious consequences for the hydraulic installation and people.

we recommend a filtration of 15 microns for its valves

## POWER SUPPLY

The solenoid valve coils must be supplied with voltages between +/- 10% of the nominal voltage at a maximum environment temperature of 60°C.

## SEALING

O-rings mounted on the valves are in NBR

The anti-extrusion rings used to protect the O-rings are made of PTFE or NBR.

## TESTING CONDITIONS

All the tests shown in the catalogue were carried out with mineral oil ISO VG 46 at a temperature of 40°C and an absolute filtration degree of 15 microns.

**MTSV228** SOLENOID VALVE 2 WAYS 2 POSITIONS, WITH EMERGENCY SAE 8/2

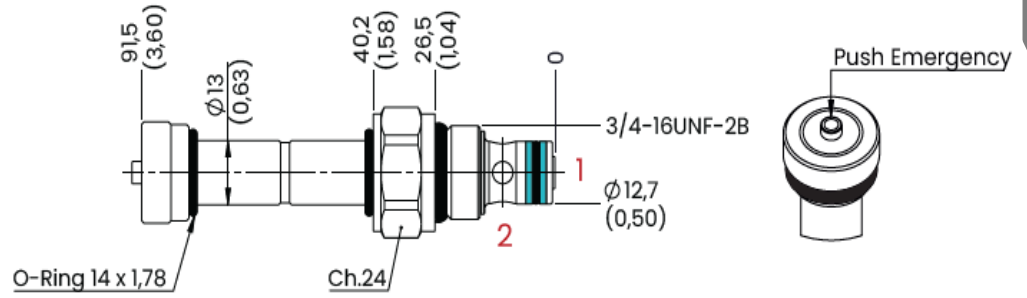

HYDRAULIC CIRCUIT

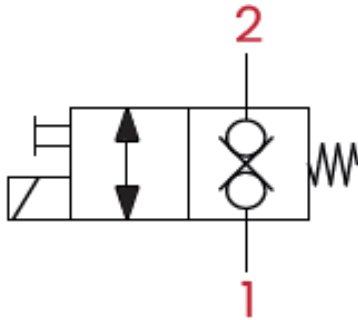

PERFORMANCES

Tests carried out with solenoids at their working temperature, with a supply voltage 10% below the nominal value.

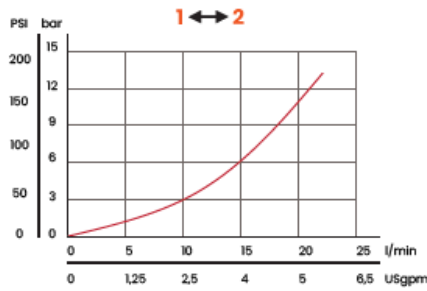

ELECTRIC

TYPE VOLTAGE	DC
INSULATION INDEX	H
NOMINAL VOLTAGE	+/- 10%
POWER AT 20°C	22W
ED*	100% with temperature -20 C° + 40 C°
COIL CODE	C22

\*For temperature or special conditions contact our sales department

ORDERING CODE

ORDERING CODE	VERSIONS	CAVITY	MAX FLOW l/min [USgpm]	MAX WORKING PRESSURE bar [PSI]	CH 24 TIGHTENING TORQUE Nm [lbt.ft]	TIGHTENING TORQUE NUT Nm [lbt.ft]	WEIGHT kg [lbt]
MTSV228	Normally closed + emergency	SAE 8/2	22 [5,8]	210 [3045]	30 [22]	2 [1,5]	0,12 [0,26]

Optional, coils C22 and connectors CN

Mineral oil: DIN 51524 ISO 6743/4 | Oil viscosity: 15 to 250 cSt 15-250 mm<sup>2</sup>/s | Oil temperature: -4°F + 176°F -20°C +80°C | Ambient temperature: -4°F + 122°F -20°C +50°C | Max contamination index with filter: 5 to 250 cSt 15-250 mm<sup>2</sup>/s | It is necessary a filter use to protect the valve (advised filtration 15 µm) | Max leakage: 0,25 cm<sup>3</sup>/min - 5 drops/min

**MTK22** 22W COILS

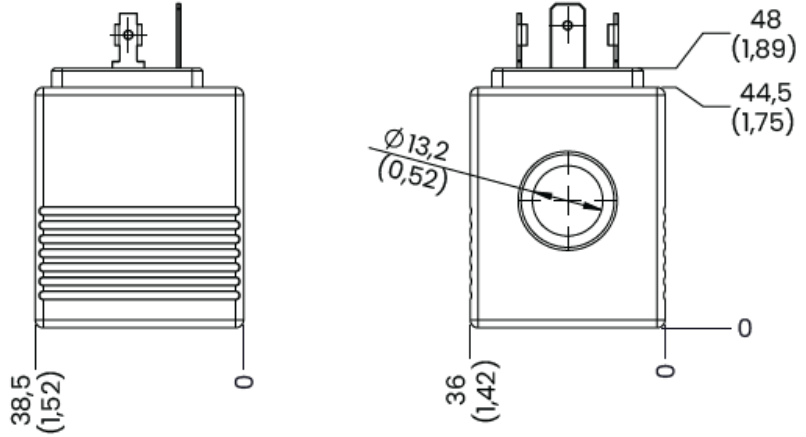
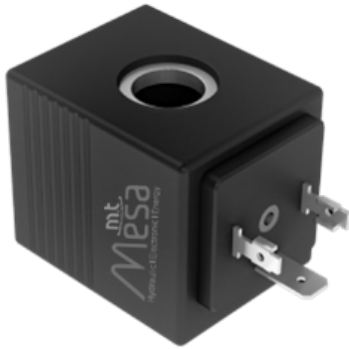

mm  
[Inches]

HYDRAULIC CIRCUIT

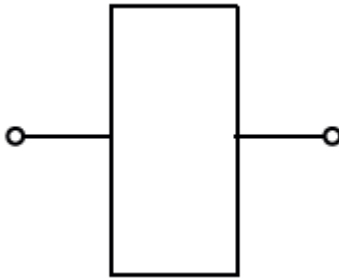

ELECTRIC

Protection class with std.connector DIN	IP 65
INSULATION INDEX	H
Wire insulation class	H
NOMINAL VOLTAGE	+/- 10%
POWER AT 20C°	22W
ED*	100% with temperature -20 C° + 40 C°

\*For temperature or special conditions contact our sales department

ORDERING CODE

ORDERING CODE	VOLTAGE	RESISTANCE	MATCHING CONNECTOR	ABSORBED POWER	TIGHTENING TORQUE Nm [lbt ft]	WEIGHT kg [lbt]
MTK2212	12Vdc	6,5 Ω	CNS [DIN 43650]	22 W	2 [1,5]	0,21 [0,46]
MTK2224	24Vdc	26,5 Ω				

**MTKE** CONNECTORS

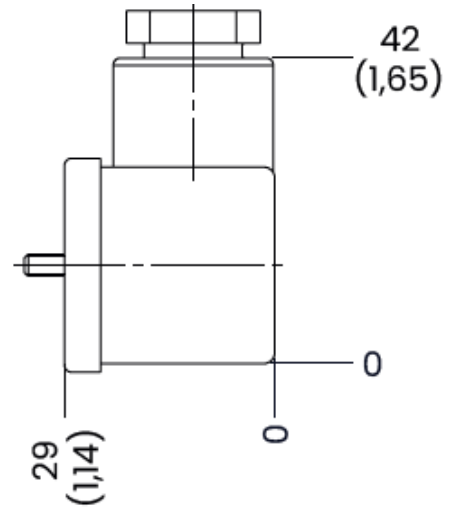
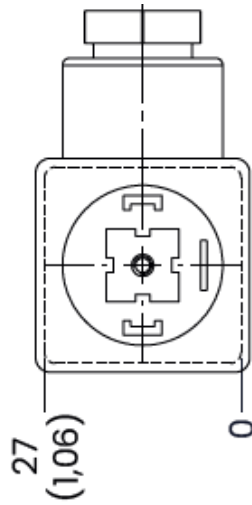

mm [Inches]

**ORDERING CODE**

ORDERING CODE	NOMINAL CURRENT	MAX OPERATING CURRENT	CONTACT RESISTANCE	MAX CONDUCTORS CROSS-SECTION	CONTACT HOLDER	GAND SIZE OPTIONS
MTKE	10 A	16 A	≤ 4m Ohm	1,5 mm <sup>2</sup>	PA (+G)	Pg11

CABLE DIAMETER	PROTECTION CLASS	ISULATION CLASS	SEALING MATERIAL	OPERATING TEMPERATURE	WEIGHT kg [lbt]
6-8 mm	IP 65 EN 60529	VDE 0110-1/89	NBR	-40° +90°	0,020 [0,044]